

# Body work Karosserien Carrosserie

## Front spoiler • Frontspoiler • Spoiler frontal



**Stilo/Unico**

Art. Nr.	Colour/Farbe/Couleur
108610	White
108611	Red
108612	Black
108613	Yellow
108614	Blue
108615	Grey



**Duo**

Art. Nr.	Colour/Farbe/Couleur
108710	White pearl
108711	Red
108712	Black
108713	Yellow
108714	Blue
108715	Grey



**194670** = Transition sleeve/Uebergangshülse/Douille transitoire



**108865** = Set (3-Teile/parts)  
**108866** = Plastic  
**108867** = Metal clamps/Satz Metallspanner/Rampons

## Nassau panel • Lenkstangenspoiler • Naseau panel



Art. Nr.	Colour/Farbe/Couleur
108620	White
108621	Red
108622	Black
108623	Yellow
108624	Blue
108625	Grey
108626	White pearl

Art. Nr.	Colour/Farbe/Couleur
108520	White
108521	Red
108522	Black
108523	Yellow
108524	Blue
108525	Grey



**129170**



**129100** = Set



**334680**



## Back spoiler • Spoiler Hinten • Spoiler arrière



**Stilo/Unico/Duo**

Art. Nr.	Colour/Farbe/Couleur
108790	White pearl
108791	Red
108792	Black
108793	Yellow
108794	Blue
108795	Grey



**108799** = Set



**108798** = Set



**108786** = Set CRG



**Panda**

Art. Nr.	Colour/Farbe/Couleur
108560	White pearl
108561	Red



**108782** = CRG

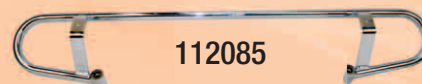

**112085**

## Stilo



### Left • Links • Gauche

Art. Nr.	Colour/Farbe/Couleur
108650	
108651	
108652	
108653	
108654	
108655	

### Right • Rechts • Droite

Art. Nr.	Colour/Farbe/Couleur
108660	
108661	
108662	
108663	
108664	
108665	

194370 = Set

194371 = Alu tube/Alu-Rohr/Tube alu

194375 = Right/Rechts/Droit (incl. Alu tube/Mit Alu-Rohr/Avec Tube alu)

194376 = Left/Links/Gauche (incl. Alu tube/Mit Alu-Rohr/Avec Tube alu)

112210 - Ø 20 mm

194372 - Ø 16 mm



## Unico



### Left • Links • Gauche

Art. Nr.	Colour/Farbe/Couleur
108630	
108631	
108632	
108633	
108634	
108635	

### Right • Rechts • Droite

Art. Nr.	Colour/Farbe/Couleur
108640	
108641	
108642	
108643	
108644	
108645	

194270 = Set

194275 = Right/Rechts/Droit

194276 = Left/Links/Gauche

## Duo

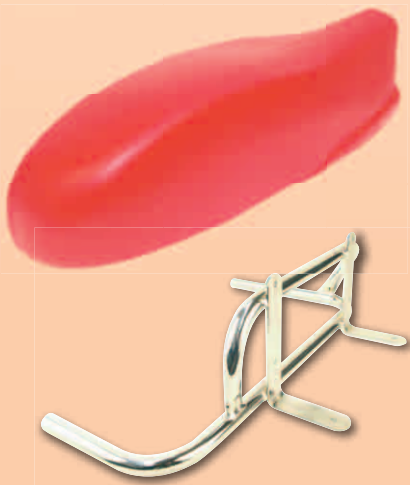

### Left • Links • Gauche

Art. Nr.	Colour/Farbe/Couleur
108730	pearl
108731	
108732	
108733	
108734	
108735	

### Right • Rechts • Droite

Art. Nr.	Colour/Farbe/Couleur
108740	pearl
108741	
108742	
108743	
108744	
108745	

194270 = Set

194275 = Right/Rechts/Droit

194276 = Left/Links/Gauche

## Mini 900

108891 = red/rot/rouge

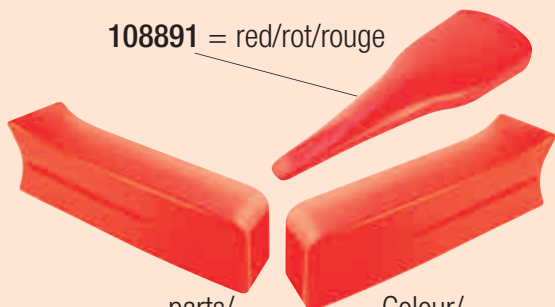

194245 = Set



Set	parts/ teilig/ parties	Colour/ Farbe/ Couleur
108878	3	■
108879	3	■
108880	3	■
108881	2	■
108882	3	■
108883	3	■

Front spoiler incl. Holder/ Frontspoiler incl. Halter/ Spoiler frontal avec fixation
108889
108888
108885
108886
108887
108884



108855 = Set

## Mini 950 Panda



194220 = Set

Frontspoiler/ Frontspoiler/ Spoiler avant	Colour/ Farbe/ Couleur	Nassau panel/ Lenkstangenspoiler/ Nasseau panel	Colour/ Farbe/ Couleur	Left/ Links/ Gauche	Colour/ Farbe/ Couleur	Right/ Rechts/ Droite	Colour/ Farbe/ Couleur
108530	□ pearl	108570	□ pearl	108540	□ pearl	108550	□ pearl
108531	■	108571	■	108541	■	108551	■

## Sticker-set • Kleberset • Set d'autocollants



999310	Stilo compl. red	■
999320	Unico compl. red	■
999322	Unico compl. black	■
999324	Unico compl. blue	■
999340	Duo compl. red	■
999330	Mini 900 compl. red	■
999335	Mini 950 compl. red "Panda"	■

# Number plates Nummernschilder Plaques à numéros

## Plates • Schilder • Plaques



## Stickers • Kleber • Autocollans

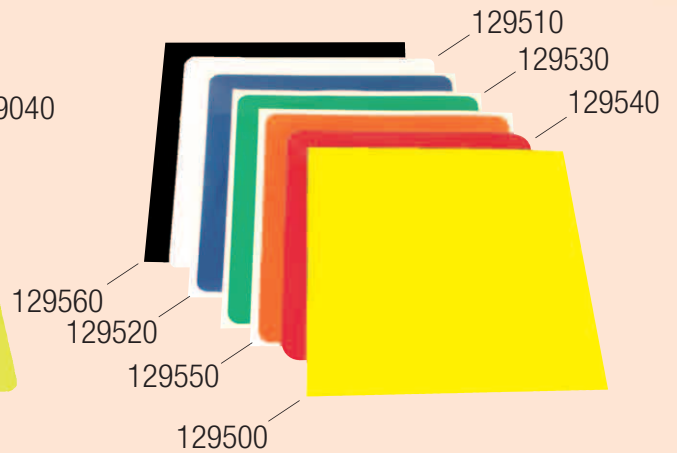

**112210** = Ø 20 mm  
Number plate clamp  
Nummernschildbride  
Bride porte-numéro

## Numbers • Startnummern • Numéros



490000 = 0  
490010 = 1  
490020 = 2  
490030 = 3  
490040 = 4  
490050 = 5  
490060 = 6  
490070 = 7  
490080 = 8  
490090 = 9

491000 = 0  
491010 = 1  
491020 = 2  
491030 = 3  
491040 = 4  
491050 = 5  
491060 = 6  
491070 = 7  
491080 = 8  
491090 = 9

492000 = 0  
492010 = 1  
492020 = 2  
492030 = 3  
492040 = 4  
492050 = 5  
492060 = 6  
492070 = 7  
492080 = 8  
492090 = 9

# Bumpers and Stabilisator

## Stossstangen und Stabilisatoren

### Pare-chocs et Stabilisateurs

Front bumpers • Stossstangen Vorne • Pare-chocs avant

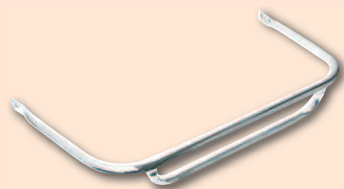

**111070**  
Up All/Oben Alle/Sup. tous

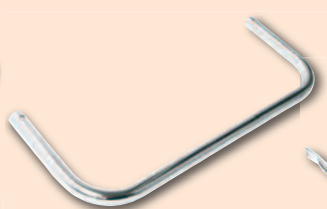

**111075**  
Down All/Unten Alle/Inf. tous

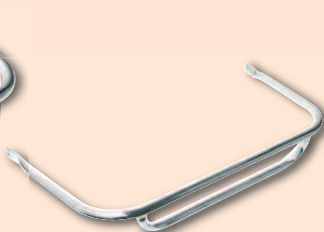

**111090** Mini



**111078**  
Long driver set /  
Set für lange Fahrer /  
Set pour pilotes longs

Back Bumpers • Stossstangen Hinten •  
Pare-chocs Arrière



**112070** Standard  
**112040** Promo  
**112095** Mini  
**112085** Mini Panda



**112075** Standard  
**112100** Promo  
**112105** Mini

### Stabilisator

Rear • Hinten • Arrière



**190070** Standard  
**190000** Promo  
**190006** Mini

Front • Vorne • Avant



**190270** Standard  
**190200** Promo  
**190206** Mini

Side • Seite • Latéral



**190170** Toxic/Diabolik

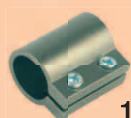

**191021** Clamp/Muffe/Bride

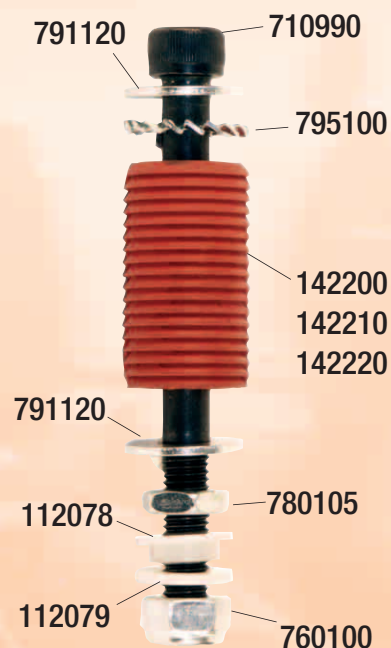

**710990** = M 10 x110 mm  
**795100** = M 10  
**791120** = M 10 x 25 x 2 mm  
**112076** = 10 x 14 - 20 x 5,5 mm  
**760100** = M 10  
**780105** = M 10  
**112078** = M 10 Nylon  
**112079** = M 10 Nylon  
**142200** = Ø 28 mm  
**142210** = Ø 30 mm  
**142220** = Ø 32 mm

# Pedals Pedale Pédales



**114000** = Brake/Bremse/Frein  
**114010** = Brake/Bremse/Frein  
Small/Japan klein/ Petit



**113000** = Accelerator/Gas/Accélérateur  
**113010** = Accelerator/Gas/Accélérateur  
Small/Japan klein/ Petit



**113051** = 77 mm Inter  
**113061** = 88 mm Mini/Promo



**115501** = Foot-support/Fussanschlage/Butee de pied

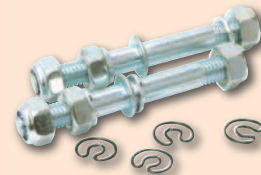

**113050** = compl. Inter  
**113060** = compl. Mini/Promo

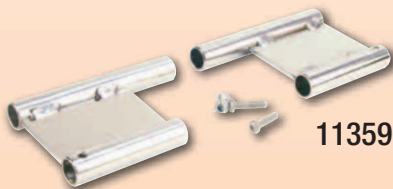

**113590** = Pedal extension/Pedalverlangerung/  
Prolongation pedales

# Floor panel Bodenblech Plancher

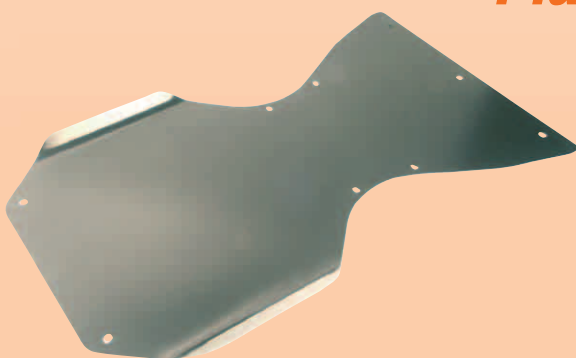

**115351** = Promo  
**115631** = Mini 900  
**115632** = Mini 950  
**115636** = Mini 1010  
**115751** = Toxic  
**115756** = Toxic ICC  
**115761** = Diabolik  
**115766** = Diabolik ICC

**115771** = Toledo  
**115776** = Toledo ICC  
**115781** = Vinto  
**115786** = Vinto ICC  
**115791** = Magic

# Gas brake cables

## Gas- Bremskabel

### Cable d'accélérateur/frein

#### Accelerator • Gas • Accélérateur



**135010**  
Gas-cable/Gaskabel/  
Câble d'accélérateur  
1800 mm



Hose/Hülle/Gaine  
**134000** = 2,5 x 5 mm = 1 m  
**134990** = 2,5 x 5 mm = 100 m



**135900**  
Hand accelerator/Handgas/  
Accélérateur à main



**139020**  
Bolt/  
ES-Bolzen/  
Boulon



**139010**  
Fork-piece/  
Gabelstück/  
Fourchette

**136000**



**133800**



**133010**

#### Brake • Bremse • Frein



**185800**  
380 mm (hydr.)



Hose/Hülle/Gaine  
**137000** = 3,2 x 7 mm = 1 m  
**137990** = 3,2 x 7 mm = 100 m



**138010** = 1300 mm

**138360** = Threaded rod single/  
Gewindestange einzel/  
Barre filetée seule



**138300** = Complete/Komplett/Complet

# Rims Felgen Jantes

## Aluminium

### Silverstar



*Front/Vorne/Avant*

**174130** = 130 mm

**154125** = 125 mm

(3 Hole/3-Loch/3 Trous)

*Rear/Hinten/Arrière*

**154180** = 180 mm

**154210** = 210 mm

### Silverstar Mini



*Front/Vorne/Avant*

**174115** = 115 mm

*Rear/Hinten/Arrière*

**154140** = 140 mm

### Blackstar Mini



*Front/Vorne/Avant*

**174343** = 120 mm

(3 Hole/3-Loch/3 Trous)

*Rear/Hinten/Arrière*

**154343** = 150 mm

## Magnesium

### Blackstar



*Front/Vorne/Avant*

**174345** = 130 mm

(3 Hole/3-Loch/3 Trous)

*Rear/Hinten/Arrière*

**154344** = 180 mm

**154345** = 210 mm

### Freeline



*Front/Vorne/Avant*

**174230** = 130 mm

(3 Hole/3-Loch/3 Trous)

*Rear/Hinten/Arrière*

**154224** = 180 mm

**154225** = 210 mm

### Race Blackstar



*Front/Vorne/Avant*

**174000** = 130 mm

(3 Hole/3-Loch/3 Trous)

*Rear/Hinten/Arrière*

**154000** = 210 mm





Small/Klein/Petit  
**154360**  
Per unit/Einzeln/Unique



Big/Gross/Grand  
**154370**  
Per unit/Einzeln/Unique

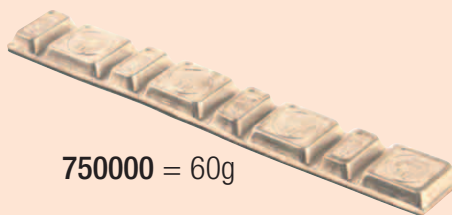

**750000** = 60g



**172070**



**154550** (incl. O-Ring)



**154540** (incl. O-Ring)



**117100** = O-Ring



**188000**

## Steering-wheels Lenkräder Volants

**Diesis**



**156450** = Ø 320 mm alcantara

**Diesis SH**



**156460** = Ø 320 mm alcantara  
With/Mit/Avec SH Logo

**Daytona**



**156470** = Ø 340 mm alcantara  
With/Mit/Avec SH Logo

**Rental**



**156800** = Ø 290 mm  
Steel/Stahl/Acier

**Sprinter**



**156200** = Ø 290 mm

**Ultralight**



**156250** = Ø 300 mm  
Alcantara

# Steering Lenkung Direction

## Steering tie rods • Spurstange • Biellettes

### Steel/Stahl/Acier



- 164050 = 235 mm
- 164000 = 265 mm
- 164010 = 275 mm
- 164070 = 290 mm

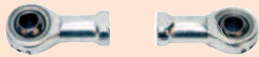

- 159000 = Right/Rechts/Droit
- 159010 = Left/Links/Gauche

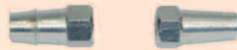

- 164100 = Right/Rechts/Droit
- 164110 = Left/Links/Gauche

### Alluminium



- 164098 = 226 mm
- 164097 = 250 mm
- 164090 = 262 mm
- 164095 = 268 mm



- 159020 = Right/Rechts/Droit
- 159030 = Left/Links/Gauche



- 780080 = Right/Rechts/Droit
- 781080 = Left/Links/Gauche

## Steering column • Lenkstange • Colonne de direction



- 158060 = 370 mm
- 158070 = 483 mm
- 158080 = 505 mm



158516 = 10°



158501 = 0°  
158521 = ICC



157000



157100



177521

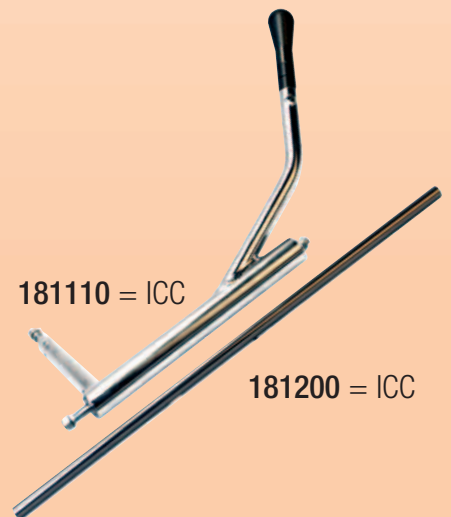

181110 = ICC

181200 = ICC



163100



163000



160000

# Stub axles Achsschenkel Fusées

## Left • Links • Gauche

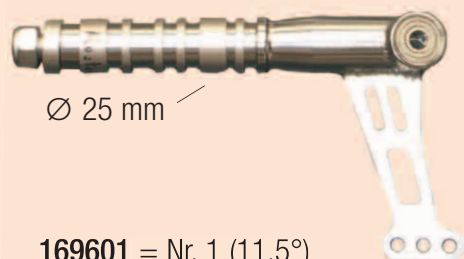

169601 = Nr. 1 (11,5°)  
169602 = Nr. 2 (12° - standard)

170010 = M14

173450

173430 = 5 mm

173440 = 15 mm

## Right • Rechts • Droite



168601 = Nr. 1 (11,5°)  
168602 = Nr. 2 (12° - standard)

170010 = M14

173405 = 5 mm

173410 = 10 mm

173430 = 20 mm

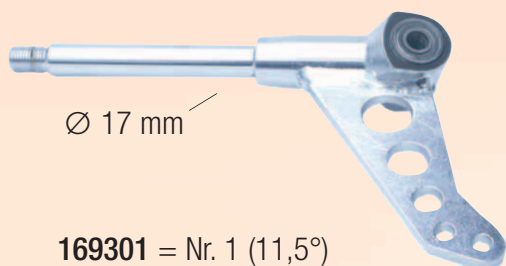

169301 = Nr. 1 (11,5°)  
169302 = Nr. 2 (12° - standard)  
169303 = Nr. 3 (12,5°)  
(Rain/Regen/Pluie)

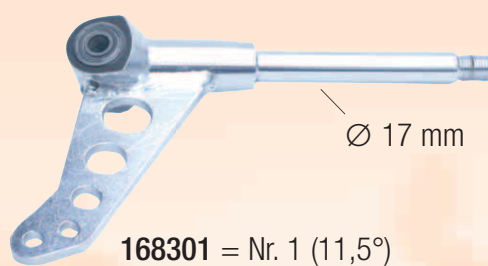

168301 = Nr. 1 (11,5°)  
168302 = Nr. 2 (12° - standard)  
168303 = Nr. 3 (12,5°)  
(Rain/Regen/Pluie)

## Mini

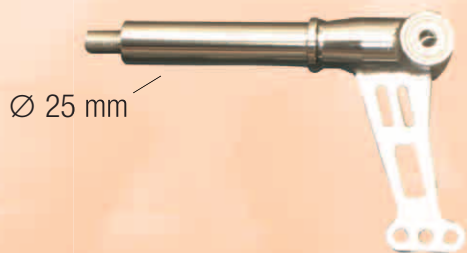

169182 = Nr. 2 (12° - standard)

170010 = M14

173450

173430 = 5 mm

173440 = 15 mm

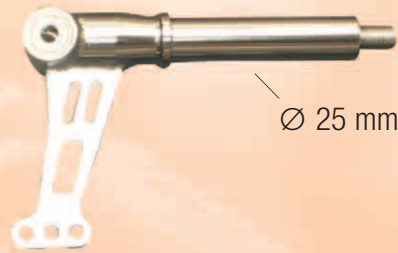

168182 = Nr. 2 (12° - standard)

## ICC

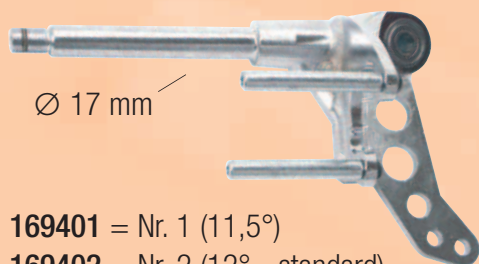

169401 = Nr. 1 (11,5°)  
169402 = Nr. 2 (12° - standard)

170010 = M14

173405 = 5 mm

173410 = 10 mm

173430 = 20 mm

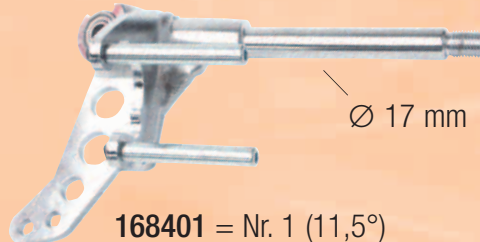

168401 = Nr. 1 (11,5°)  
168402 = Nr. 2 (12° - standard)

## Stub axles accessories • Achsschenkel-Zubehör • Accessoires fusées

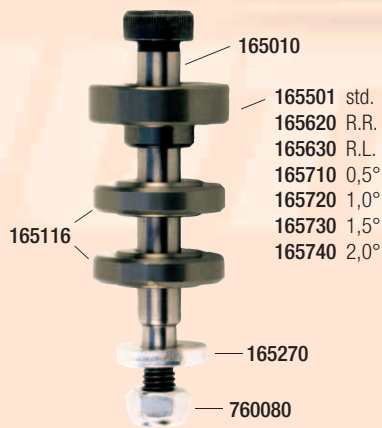

165010

165501 std.  
165620 R.R.  
165630 R.L.  
165710 0,5°  
165720 1,0°  
165730 1,5°  
165740 2,0°

165116

165270

760080

165501 = standard

165710 = 0,5°

165720 = 1,0°

165730 = 1,5°



165740 = 2,0°

165620 = R.R.

165630 = R.L.



165020 = Excentric Bolt/  
Exzenterbolzen/Boulon excentriques



165117 = Vertical  
adjustment set/Set  
Höhenverstellung/Kit réglage  
hauteur



165850



193000

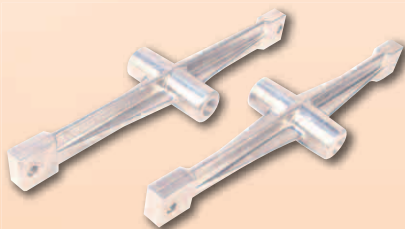

584000 = Ø 17 mm  
Adjustment bar/  
Spureinstellbalken/  
Barres de réglage



584100 = Ø 17 mm  
Adjustment discs/  
Spureinstellscheiben/  
Disques de réglage



584125 = Ø 25 mm  
Adjustment discs/  
Spureinstellscheiben/  
Disques de réglage

### Parallelism

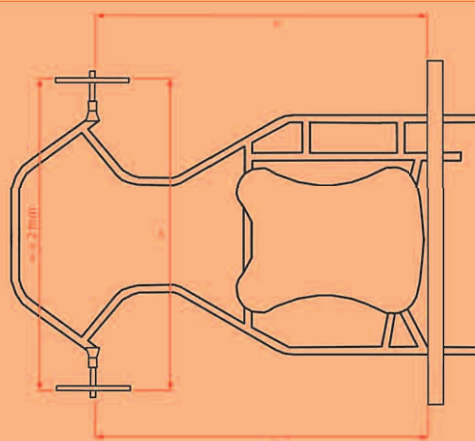

# Seats Sitze Sièges

## Polyester standard

### Swiss Hutless



- 120000 = Cadet (0)
- 120005 = Puffo/Baby
- 120006 = Puffo/Baby 2
- 120010 = Small (1)
- 120020 = Medium (2)
- 120030 = Large (3)
- 120040 = XL (4)
- 120050 = XXL (5)

### Neutral



- 120390 = Cadet (0)
- 120400 = Small (1)
- 120410 = Medium (2)
- 120420 = Large (3)
- 120430 = XL (4)
- 120440 = XXL (5)

## Tillett



T9

- 120281 = MS
- 120282 = ML
- 120283 = L
- 120284 = XL



T11

- 120269 = XS
- 120270 = S
- 120271 = MS
- 120272 = ML
- 120273 = L
- 120274 = XL



T8

- 120290 = Cadet
- 120291 = MS
- 120292 = ML
- 120293 = L
- 120294 = XL



T7

- 120250 = Cadet
- 120260 = XS
- 120200 = MS
- 120210 = ML
- 120220 = L
- 120230 = XL
- 120240 = XXL
- 120245 = XXXL

## Lead Blei Plomb



- 751000 = 1Kg
- 751010 = 2Kg
- 751020 = 4Kg

## Accessories • Zubehör • Accessoires



**120821** = Set seat paddings/  
Satz Sitzpolster/  
Set rembourrage siège

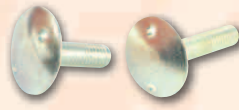

**121000** = M 8 x 25 mm  
**121010** = M 8 x 40 mm



**121100** = M 8 x 25 mm  
**121120** = M 8 x 40 mm



**122000** = 40 x 8,5 x 2 mm



**122100** = Plastic

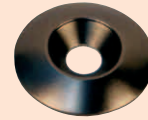

**122120** = Alu



**122005** = 6 x 60 mm



**121200** = Screw - set for 1 seat/  
Schraubenset für 1 Sitz/  
Set de vis pour 1 siège



**123401** = Ø 28 mm  
**123406** = Ø 30 mm  
**123411** = Ø 32 mm



**123220** = 340 mm



**123200** = 320 mm



**123210** = 300 mm



**123205** = 280 mm



**123430** = 350 mm



**123420** = 250 mm

### Seat position

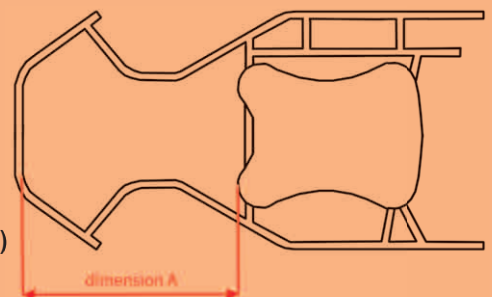
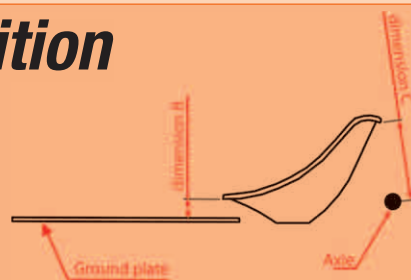

Driver	dimension A (mm)	dimension B (mm)	dimension C (mm)
1,45 to 1,55 m	580	95	220
1,55 to 1,70 m	590	90	210
1,70 to 1,80 m	600	85	200
1,80 to 1,90 m	610	85	190

# Fuel tanks Benzintank Réservoirs



**116020**  
Mini 3l (Ø 37 mm)



**116030**  
Promo 6l (Ø 37 mm)



**116021**  
Mini 3l (Ø 40 mm)



**116040**  
CIK 8,5l (Ø 40 mm)



**117030** = Ø 37 mm incl. O-Ring  
**117100** = O-Ring



**117050** = Ø 40 mm incl. O-Ring  
**117150** = O-Ring



**117040** = Ø 20 mm



**117020** = Ø 23 mm



**116510**



**118110**



**118000**



**119010** = 2 m  
Blue/Blau/Bleu



**119020** = 10 m  
Blue/Blau/Bleu

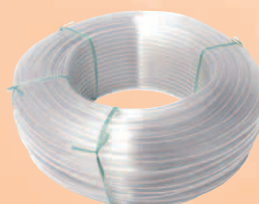

**119100** = 100 m  
White/Weiss/Blanc



**117510**

# Exhaust holder Auspuffhalter Support d'échappement



131000



130100 = 30 x 8 x 12 mm



131080



132100 = 115 x 90 x 1.5 mm



280000



280100

## Set Rotax Max



131090



130090

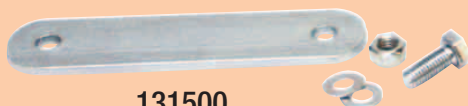

131500



131094 Ø 30 mm

131096 Ø 32 mm



131092



# Engine Mounts Motorsupporte Platines de moteur

## Design

---

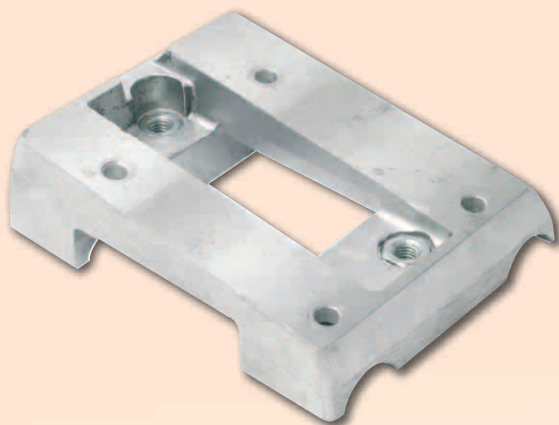

- 125020 = 92 x 28 mm IAME Gazelle
- 125030 = 92 x 28 mm Comer W60
- 125090 = 92 x 28 mm Without hole/Ohne Loch/Sans trous

## Longlife

---

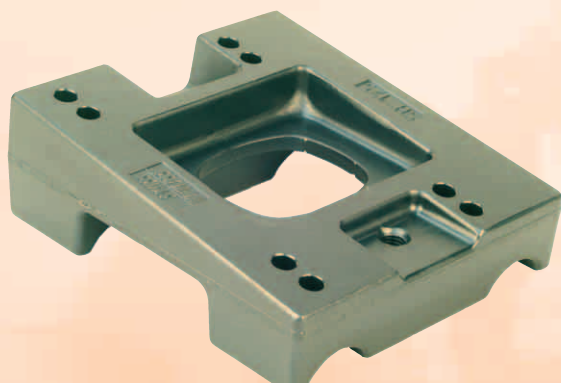

- 125125 = 92 x 30 mm IAME Swift, Rotax Max
- 125126 = 92 x 32 mm IAME Swift, Rotax Max
- 125170 = 92 x 30 mm Vortex VLC/VRC/Piston Port
- 125171 = 92 x 32 mm Vortex VLC/VRC/Piston Port
- 125195 = 92 x 30 mm Without hole/Ohne Loch/Sans trous
- 125196 = 92 x 32 mm Without hole/Ohne Loch/Sans trous

## Magnesium

---

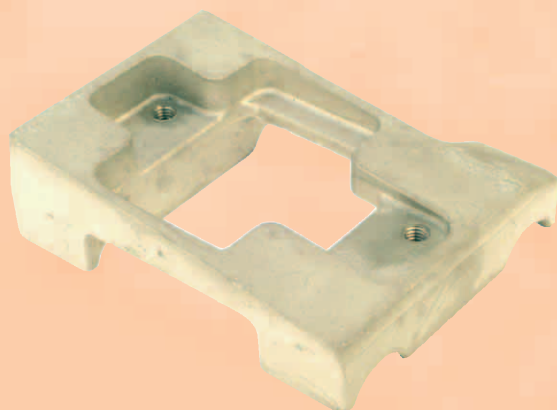

- 125200 = 92 x 30 mm Without hole/Ohne Loch/Sans trous
- 125250 = 92 x 32 mm Without hole/Ohne Loch/Sans trous

## Flat • Flach • Plat

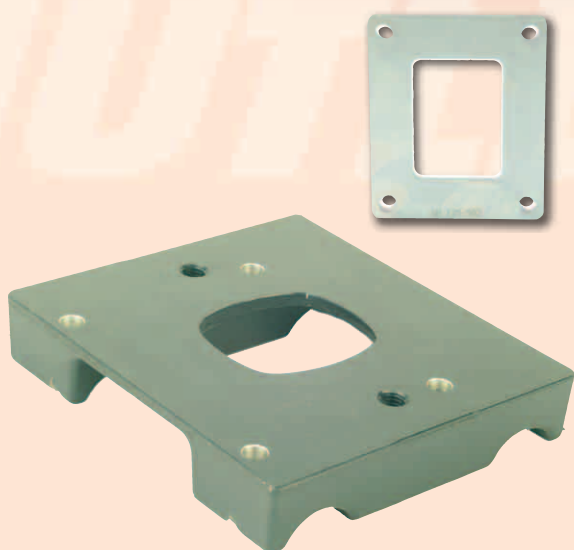

- 125500** = Plate/Zwischenplatte/Plaque  
Without hole/Ohne Loch/Sans trous
- 125502** = Plate/Zwischenplatte/Plaque Vortex RVA

- 125510** = 92 x 30 mm Without hole/Ohne Loch/Sans trous
- 125512** = 92 x 32 mm Without hole/Ohne Loch/Sans trous
- 125520** = 92 x 30 mm Vortex RVA/ROK, IAME Leopard
- 125522** = 92 x 32 mm Vortex RVA/ROK, IAME Leopard
- 125530** = 92 x 30 mm Parilla Reedster
- 125532** = 92 x 32 mm Parilla Reedster

## Counter-part • Gegenstück • Brides



- 127000** = 90 x 28 mm
- 127030** = 90 x 32 mm
- 127420** = 90 x 30 mm

## 125

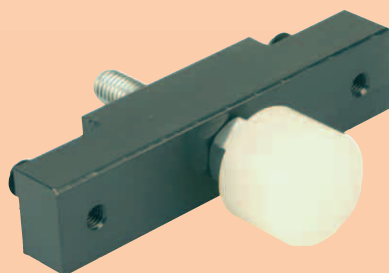

- 125980** = Holder/Halter/Support 125 ICC

# Rear axles Hinterachsen Axes arrières

Art. Nr.	Ø	L	Kat.	Typ.
147006	25 mm	980 mm	Mini	medium (std.)
147007	25 mm	980 mm	Mini	soft
147026	25 mm	1020 mm	Promo-World	medium (std.)
147061	30 mm	1050 mm	Promo	soft
147345	30 mm	960 mm	Mini-1010	medium (std.)
147347	30 mm	980 mm	Mini	medium (std.)
147349	30 mm	980 mm	Mini	soft
147450	40 mm	1050 mm		hard
147455	40 mm	1050 mm		medium (std.)
147456	40 mm	1050 mm		soft
147457	40 mm	1050 mm		super-soft
147460	40 mm	1050 mm	DD2	medium (std.)
147725	50 mm	1040 mm	Inter.	medium (std.)
147726	50 mm	1040 mm	Inter.	soft
147732	50 mm	1040 mm	Inter.	super-soft
147727	50 mm	1040 mm	Inboard	medium (std.)
147728	50 mm	1040 mm	Inboard	soft
147729	50 mm	1040 mm	125 ICC	medium (std.)
147730	50 mm	1040 mm	125 ICC	soft



## Keys • Keile • Clavettes

- 148000 = (Ø 25-30 mm) 6 x 6 x 50 mm
- 148010 = (Ø 25-30 mm) 6 x 6 x 70 mm
- 148450 = (Ø 40 mm) 7,9 x 4,5 x 60 mm
- 148451 = (Ø 40 mm) 7,9 x 4,5 x 40 mm
- 148650 = (Ø 50 mm) 8 x 3,4 x 60 mm (2 Knobs/Noppen/Guides)
- 148651 = (Ø 50 mm) 8 x 3,4 x 60 mm (3 Knobs/Noppen/Guides)



## Rear axle bearings Achslager Roulements d'axe



- 152010 = Ø 25 mm
- 152030 = Ø 30 mm

- 152050 = Ø 40 mm
- 152650 = Ø 50 mm



- 152500 = Ø 25-30 mm
- 152510 = Ø 40-50 mm



- 151910 = 16/8 x 4 mm  
Guide bush for bearing support/  
Hülse zu Lagerbock/  
Douille porte-roulement

# Bearing support Lagerschalen Portes roulements

151641 = Ø 40 mm  
151651 = Ø 50 mm



→ '06  
151301 = Ø 25 mm  
151321 = Ø 30 mm



151642 = Ø 40 mm  
151652 = Ø 50 mm



'07 →  
151621 = Ø 25 mm  
151631 = Ø 30 mm



Brake side/Bremsseite/Côté frein

151643 = Ø 40 mm  
151653 = Ø 50 mm



Brake side with holder/  
Bremsseite mit Halter/  
Côté frein avec support

'07 →  
151622 = Ø 25 mm  
151632 = Ø 30 mm



Brake side/Bremsseite/Côté frein

# Sprocket support Zahnkranzhalter Porte couronne



145511 = Ø 25 mm  
145521 = Ø 30 mm  
145551 = Ø 40 mm  
145651 = Ø 50 mm



145200 = Ø 50 mm magnesium

# Wheel hubs Radnaben Moyeux

## Front • Vorne • Avant



173001 = Ø 17 x 70 mm  
173022 = Ø 25 x 60 mm



173020 = Ø 25 x 36 mm



173011 = Ø 17 x 90 mm  
173021 = Ø 25 x 85 mm

ICC



173061 = Ø 40x70 mm

173051 = Ø 40x70 mm

ICC



173900 = 7,9 x 4 x 50 mm

## Rear • Hinten • Arrière



153331 = Ø 25 x 37 mm  
153346 = Ø 30 x 37 mm



153401 = Ø 25 x 70 mm  
153421 = Ø 30 x 70 mm



153551 = Ø 40 x 100 mm



153641 = Ø 50 x 60 mm



153651 = Ø 50 x 90 mm



153200 = Ø 50 x 98 mm  
magnesium

## Accessories • Zubehör • Accessoires

173005 = Ø 17 mm



173025 = Ø 25 mm



173026



758206



172070



172090



154360 small/klein/petit  
154370 big/gross/grand

# Sprockets Zahnkränze Couronnes

## Typ 219



143660 = 66 Z	143760 = 76 Z	143860 = 86 Z
143670 = 67 Z	143770 = 77 Z	143870 = 87 Z
143680 = 68 Z	143780 = 78 Z	143880 = 88 Z
143690 = 69 Z	143790 = 79 Z	143890 = 89 Z
143700 = 70 Z	143800 = 80 Z	143900 = 90 Z
143710 = 71 Z	143810 = 81 Z	143910 = 91 Z
143720 = 72 Z	143820 = 82 Z	143920 = 92 Z
143730 = 73 Z	143830 = 83 Z	143930 = 93 Z
143740 = 74 Z	143840 = 84 Z	143940 = 94 Z
143750 = 75 Z	143850 = 85 Z	143950 = 95 Z

## ICC 1/2"



143121 = 50 mm 21 Z	143220 = 40 mm 22 Z
143122 = 50 mm 22 Z	143230 = 40 mm 23 Z
143123 = 50 mm 23 Z	143240 = 40 mm 24 Z
143124 = 50 mm 24 Z	143250 = 40 mm 25 Z
143125 = 50 mm 25 Z	143260 = 40 mm 26 Z
143126 = 50 mm 26 Z	143270 = 40 mm 27 Z
143127 = 50 mm 27 Z	143280 = 40 mm 28 Z
143128 = 50 mm 28 Z	143290 = 40 mm 29 Z
143129 = 50 mm 29 Z	143300 = 40 mm 30 Z
143130 = 50 mm 30 Z	

## 1/2"

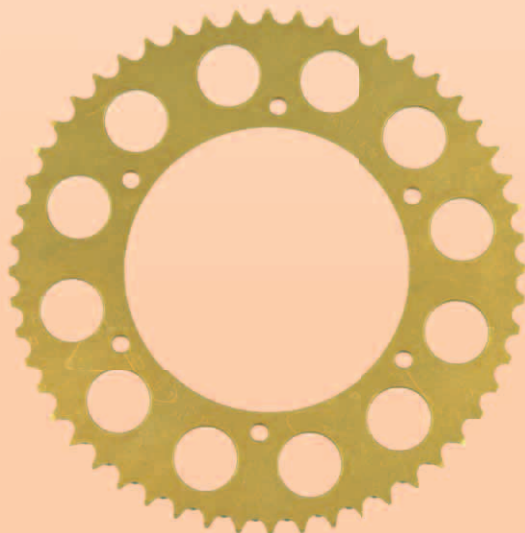

143548 = 48 Z
143550 = 50 Z
143552 = 52 Z

# Chains Ketten Chaînes

## DID 219 G&G

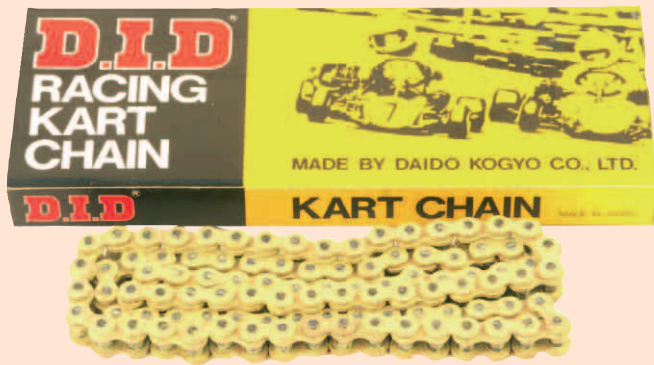

- 567800 = 96 links
- 567810 = 100 links
- 567820 = 102 links
- 567830 = 104 links
- 567840 = 106 links
- 567850 = 108 links
- 567860 = 110 links
- 567870 = 112 links
- 567880 = 114 links

## RK 219 O-ring



- 567910 = 100 links
- 567720 = 102 links
- 567730 = 104 links
- 567740 = 106 links
- 567750 = 108 links
- 567760 = 110 links
- 567770 = 112 links

## DID 428 ICC



- 566100 = DID Gold/Or 60 cm
- 566120 = DID Gold/Or 90 cm

# Chain guard Kettenschutz Protège chaîne

192020 = Lamelle

192000 = Rotary

192060 = Mini + ICC + KF



192520 = Tillett

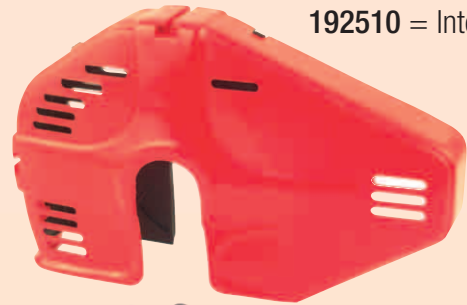

192510 = Integrale

192590 = Rubber/Gummi/Gomme  
For/Zu//Pour 192510



## Holder • Halter • Support

*Mini/Promo*

192210 = 185 mm



192200 = 125 mm

*Inter*

192220 = 100 mm



192230 = 155 mm





# Front brake Vorderradbremse Frein avant

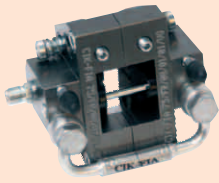

180051 = Right/Rechts/Droit Titan

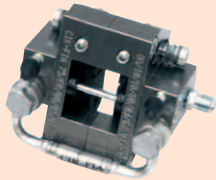

180056 = Left/Links/Gauche Titan



141130 → '05

141310 '06 →



180052



179250



138300 = Complete/Komplett/Complet

138360 = Threaded rod single/Gewindestange einzel/Barre filetée seule

# Rear brake Hinterbremse Frein arrière



180011  
Longlife



180031  
Hightech EVO



180026  
Mini



180021  
Hightech



180933



141030

141900



141615



141230



141610



141510

# Brake tube Bremsleitung Conduites de frein



179040 600 mm Magic/Vinto/Toledo/Toxic/Diabolik

179050 665 mm Promo

179060 400 mm Mini 900/950

179070 440 mm ICC

Front brake pump/Hauptbremszylinder vorne/Pompe de frein avant

179080 550 mm ICC/Mini 1010

Front brake L+R/  
Bremszange L+R/  
Pince de frein G+D

# Brake disk support Bremsscheibenhalter Support de disque de frein



153331 = Ø 25 mm  
153341 = Ø 30 mm



149451 = Ø 40 mm  
149651 = Ø 50 mm  
149200 = Ø 50 mm magnesium



149901 = Ø 40 mm



149461 = Ø 40 mm  
149661 = Ø 50 mm



173051 = Ø 40x70 mm  
Front/Vorne/Avant

## Brake disk • Bremsscheibe • Disque de frein

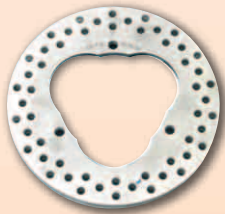

150120 = Ø 148 mm  
Front/Vorne/Avant



150900 = Ø 185 mm  
Mini

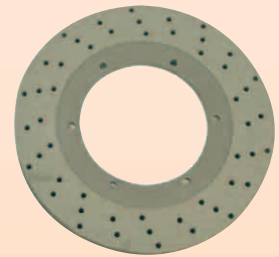

150500 = Ø 210 mm Aluminium  
with holder/mit Halter/avec support



150031 = Ø 210 mm Inter  
(6 Hole/6-loch/6 Trous)

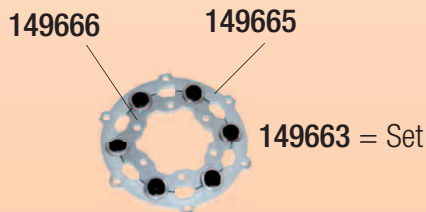

- 149667
- 149668
- ⌋ 149669



150030 = Ø 210 mm  
(3 Hole/3-Loch/3 Trous)

# Brake system Bremssysteme Systèmes freins

## ICC + Mini

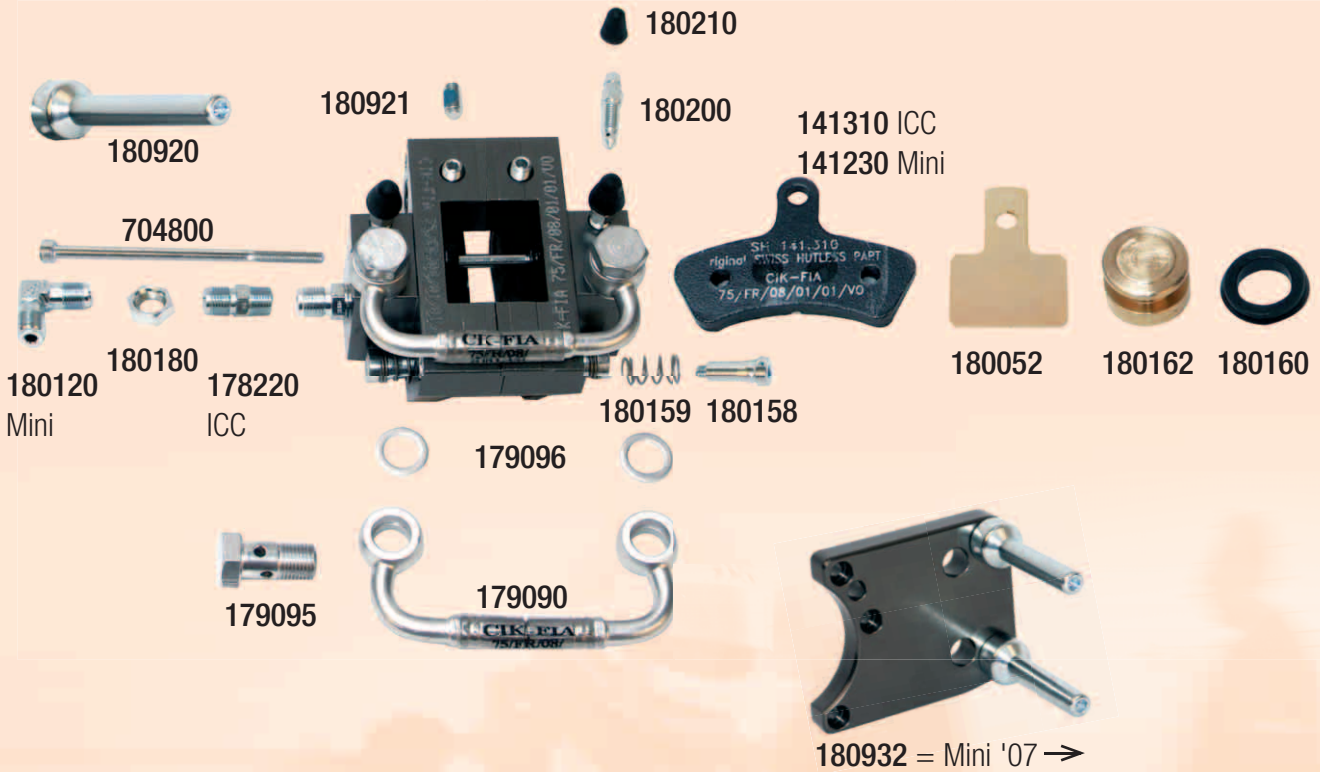

## Hightech EVO

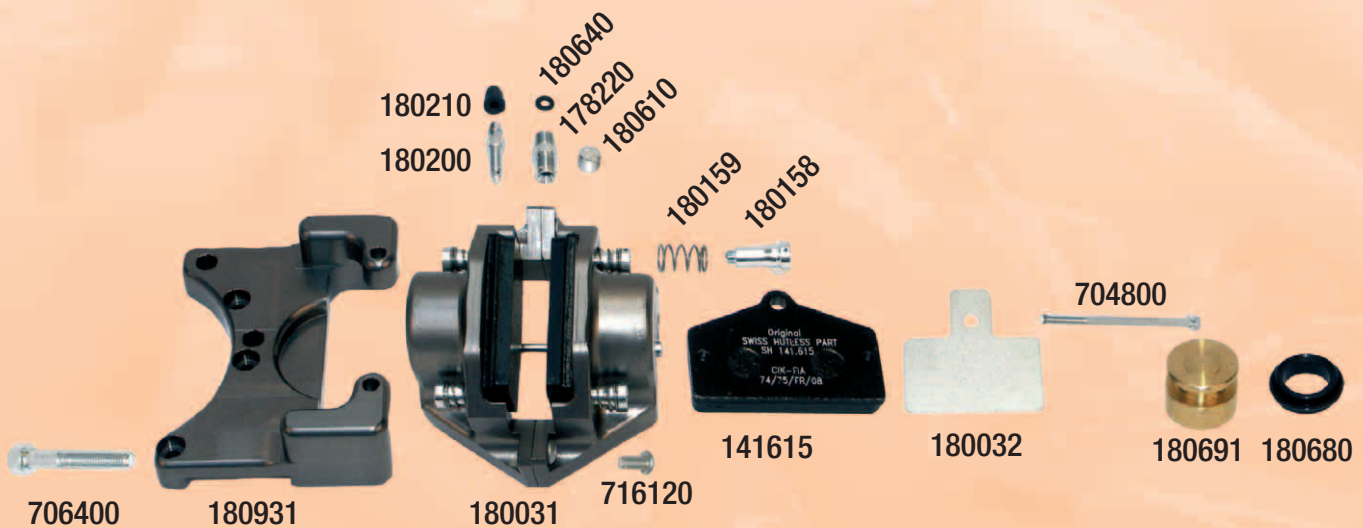

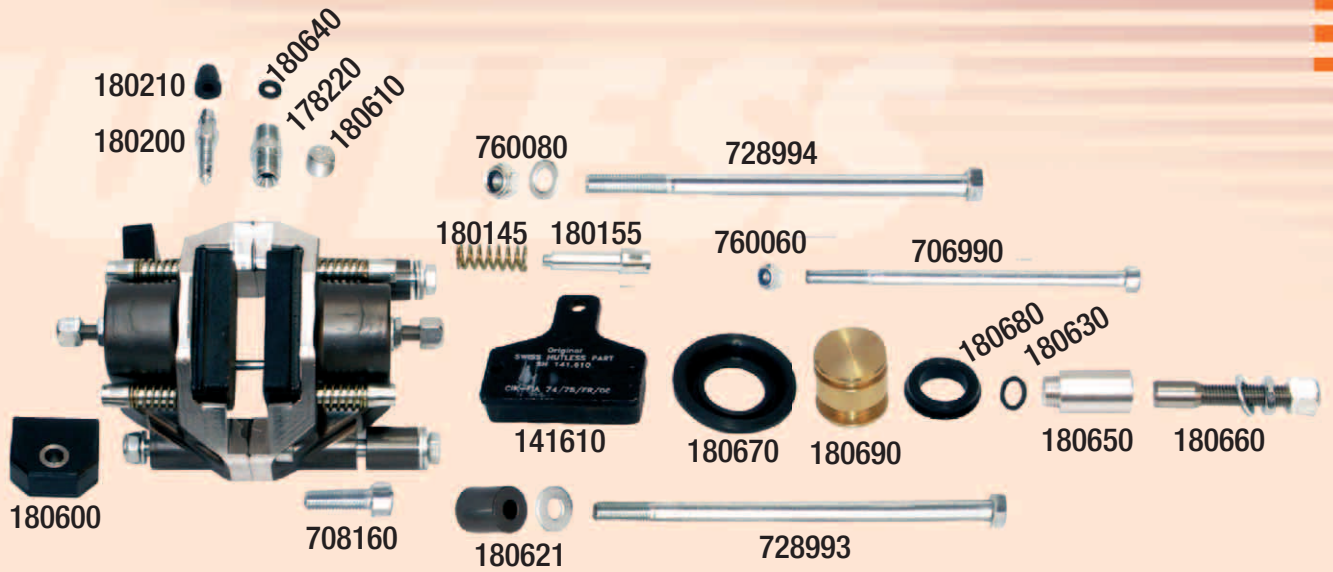

Brake pump • Hauptbremszylinder • Pompe de frein

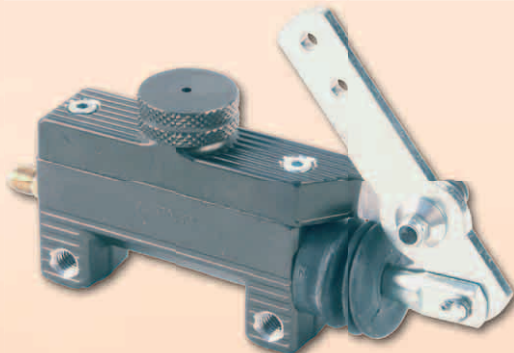

178001 = Rear/Hinten/Arrière

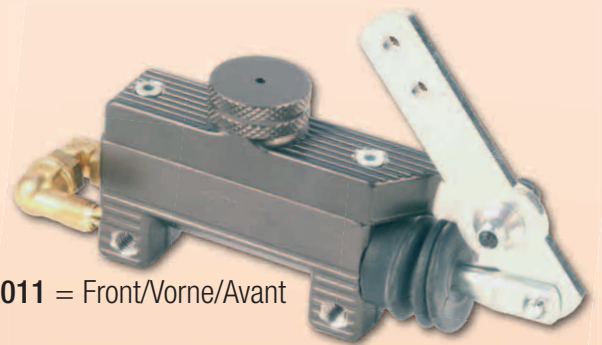

178011 = Front/Vorne/Avant

